



StorFly® 2.5-Inch SATA Solid-State Drive

SATA-III (6Gb/s) - Series 3 (Gen1), 3D TLC

VSFE25CI060G-V11

Datasheet - Rev. 0.90 - Preliminary



1. Description

Virtium's StorFly® 2.5" CE class is high-performance SATA-III 6Gb/s embedded solid-state drive (SSD) technology designed for the unique capacity and workload requirements of a broad range of embedded systems, including networking, industrial automation, medical monitoring and gaming equipment, point-of-sale terminals and data recorders.

Features

Capacity

- 60 GB

3D TLC NAND

Sequential Performance

- 128kB Sequential Read: 550 MB/s (QD: 32)
- 128kB Sequential Write: 290 MB/s (QD: 32)

Power: 5.0V±10%

- 128kB Sequential Read: 1.70 W
- 128kB Sequential Write: 1.90 W
- Idle: 1.30 W

Temperature Ranges

- Industrial: -40°C to 85°C
- Non-Operating: -40°C to 85°C

Reliability

- Advanced LDPC ECC
- MTBF: >2M hours

Endurance

- JESD219A: 48 TBW
- Sequential: 65 TBW

vtGuard® Power Fail Protection

- Integrated power fail protection
- Preserves static data in the event of power failure
- Cache/buffer contents restored at power-on

SMART Attribute Reporting

- Monitors device health
- Anticipates and predicts failures

Mechanical Dimensions

- 2.5-Inch Form Factor
- Length x Width x Height mm (inches)
100.5 (3.96) x 69.85 (2.75) x 7.0 (0.275)

Compliance

- SATA Revision 3.1 (SATA-III 6Gb/s)
- ATA/ATAPI-8 (ACS-3)
- FCC, CE, UL, RoHS, WEEE

Environmental (Non-operating)

- Humidity (non-condensing): 5% to 95%
- Shock: 1500G, half-sine wave, 0.5ms duration
- Vibration: 20G, 20 Hz to 2000 Hz

Optional Data Security⁽¹⁾

- Integrated AES-256 encryption (data-at-rest)
- TCG/ Opal 2.0-compliant SED
- Crypto and military secure

StorKit™ Software - visit virtium.com to learn more.

- vtView®
- vtSecure™
- vtTools™

Note: (1) Available in parts with -T part number extension



Electrostatic Discharge (ESD) can damage this device. When handling the device, always wear a grounded wrist strap and use a static dissipative surface.



Any damage to the unit that occurs after its removal from the shipping package and ESD protective bag is the responsibility of the user.

Part Numbering System

V SF E25 C I 060G - V11

Where:	
V	= Virtium
SF	= StorFly
E25	= Form Factor / Interface: E25 = 2.5-Inch, SATA-III 6Gb/s
C	= Product Class: C = CE
I	= Operating Temperature: I = Industrial (-40°C to 85°C)
060G	= 060G = 60GB (1GB = 1,000,000,000 bytes)
V11	= Virtium Proprietary

2. Specifications

Capacity

Unformatted Capacity ⁽¹⁾ (GB)	User-Addressable LBA ⁽²⁾	User-Addressable Capacity Bytes
60	117,231,408	60,022,480,896
(1) 1GB = 1,000,000,000 bytes. LBA: Logical Block Address; Logical Block Size = 512 Bytes/1 Sector. (2) LBA: Logical Block Address; Logical Block Size = 512 Bytes/1 Sector.		

Performance

Capacity GB	Performance Throughput ⁽¹⁾ 128kB File, Queue Depth (QD) = 32	
	Sequential Read MB/s	Sequential Write MB/s
60	550	290
(1) Performance is based on fresh out-of-box condition formatted with NTFS filesystem and running CrystalDiskMark 7.0.0 with file size 1024MB. Actual results may vary depending on file system, workload, and SSD condition.		

Power Consumption - 5V Supply

Sequential Read ⁽¹⁾ 128kB, QD = 32	Sequential Write ⁽¹⁾ 128kB, QD = 32	Idle
1.70 W	1.90 W	1.30 W
(1) Power consumption tests were done using Oakgate test system at 25°C		

Temperature and Humidity

Part Number	Operating Temperature	Non-Operating ⁽¹⁾ Temperature	Humidity (Non-Condensing)
VSFE25CI060G-V11	-40°C to 85°C	-40°C to 85°C	5% to 95%
(1) Maximum non-operating temperature assumes data is stored on the SSD. Temperatures above 85°C are beyond NAND specification for data retention. Please see <i>Temperature Considerations for Industrial Embedded SSDs</i> whitepaper under the industrial SSD section of Virtium website (Virtium.com)			

Shock and Vibration

Reliability	Test Conditions	Reference Standards
Shock	1500G, half-sine wave, 0.5ms duration	JESD22-B110B.01
Vibration	20G, 20 Hz to 2000 Hz	JESD22-B103B.01

3. Reliability

Endurance

Capacity (GB)	JESD218A ⁽¹⁾ & JESD219 Enterprise Workloads		100% Sequential Workloads	
	Total Bytes Written TBW (TB)	Drive Writes per day (3 years)	Total Bytes Written TBW (TB)	Drive Writes per day (3 years)
60	48	0.73	65	0.99
(1) JESD218A assumes an active temperature at 55°C and a retention temperature at 40°C				

Mean Time Between Failures (MTBF)

The SSD achieves a MTBF of greater than 2,000,000 hours predicted and is derived from the component reliability data using Telcordia SR-332 methods at 40°C and tested under standard environmental operating conditions.

VtGuard® Power-Fail Protection

vtGuard® is an integrated power failure protection technology that will preserve data on the SSD if a sudden power failure should occur. It will also transfer the write cache (metadata, mapping tables) contents to the non-volatile flash and restore the contents upon power restoration. This data will be preserved regardless of the duration of the power failure event. This technology also ensures that the SSD will be recoverable after sudden power failure events although a rebuild of the mapping tables may delay readiness of the SSD on the ensuing power cycle on larger capacities.

4. Physical Specifications

Pin Layout / Assignments

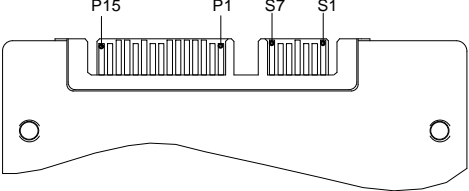
 <p style="text-align: center;">Pin Layout</p>			Power Pin Assignments		
			Pin	Signal	Description
			P1	V33	No Connect
			P2	V33	No Connect
			P3	DEVSLP	Enter/Exit Device Sleep
			P4	GND	Ground
			P5	GND	Ground
			P6	GND	Ground
			P7	V5	5V Power
			P8	V5	5V Power
			P9	V5	5V Power
			P10	GND	Ground
			P11	DAS/DSS	Device Activity Signal
			P12	GND	Ground
			P13	V12	No Connect
			P14	V12	No Connect
			P15	V12	No Connect
Signal Pin Assignments					
Pin	Signal	Description			
S1	GND	Ground			
S2	A	Differential signal pair A and A#			
S3	A#				
S4	GND	Ground			
S5	B#	Differential signal pair B and B#			
S6	B				
S7	GND	Ground			

Mechanical Dimensions

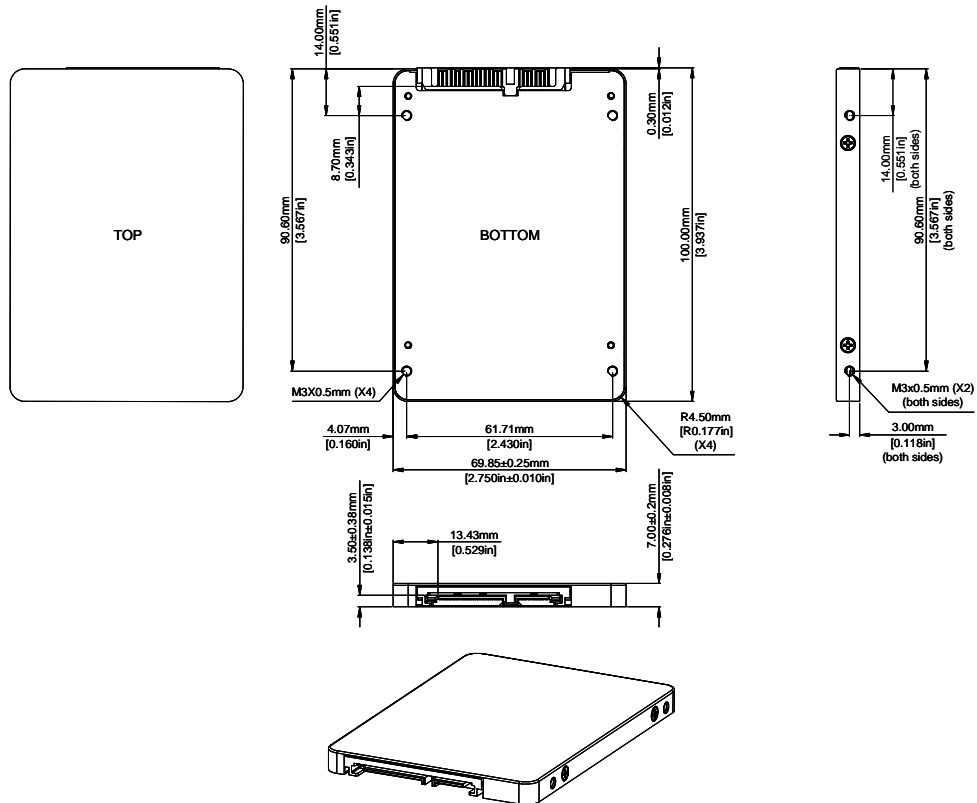

5. ATA Commands

The SSDs support all mandatory ATA commands as defined in the ATA/ATAPI-8 (ACS-3) specification.

General Feature Set

Command	Code	Protocol
Execute Device Diagnostic	90h	Execute Device Diagnostic
Flush Cache	E7h	Non-data
Identify Device	ECh	PIO data-in
Read DMA	C8h	DMA
Read Multiple	C4h	PIO data-in
Read Sector(s)	20h	PIO data-in
Read Verify Sector(s)	40h or 41h	Non-data
Set Feature	EFh	Non-data
Set Multiple Mode	C6h	Non-data
Write DMA	CAh	DMA
Write Multiple	C5h	PIO data-out
Write Sector(s)	30h	PIO data-out
NOP	00h	Non-data
Read Buffer	E4h	PIO data-in
Write Buffer	E8h	PIO data-out
Write Buffer DMA	E9h	DMA
Download Microcode	92h	PIO data-out
Download Microcode DMA	93h	DMA

Power Management

Command	Code	Protocol
Check Power Mode	E5h	Non-data
Idle	E3h	Non-data
Idle Immediate	E1h	Non-data
Sleep	E6h	Non-data
Standby	E2h	Non-data
Standby Immediate	E0h	Non-data

Sanitize

Command	Code	Protocol
Sanitize	B4h	Non-data

Security Mode

Command	Code	Protocol
Security Set Password	F1h	PIO data-out
Security Unlock	F2h	PIO data-out
Security Erase Prepare	F3h	Non-data
Security Erase Unit	F4h	PIO data-out
Security Freeze Lock	F5h	Non-data
Security Disable Password	F6h	PIO data-out

SMART Commands

Command	Code	Protocol
SMART Disable Operations	B0h	Non-data
SMART Enable/Disable Autosave	B0h	Non-data
SMART Enable Operations	B0h	Non-data
SMART Execute OFF-LINE Immediate	B0h	Non-data
SMART Read Log	B0h	PIO data-in
SMART Read Data	B0h	PIO data-in
SMART Read Threshold	B0h	PIO data-in
SMART Return Status	B0h	Non-data
SMART Save Attribute Values	B0h	Non-data
SMART Write Log	B0h	PIO data-out
SMART Write Thresholds	B0h	PIO data-out

Host Protected Area

Command	Code	Protocol
Read Native Max Address	F8h	Non-data
Set Max Address	F9h	Non-data
Set Max Set Password	F9h	PIO data-out
Set Max Lock	F9h	Non-data
Set Max Freeze Lock	F9h	Non-data
Set Max Unlock	F9h	PIO data-out

48-bit Address Feature Set

Command	Code	Protocol
Flush Cache Ext	EAh	Non-data
Read Sector(s) Ext	24h	PIO data-in
Read DMA Ext	25h	DMA
Read Log Ext	2Fh	PIO data-in
Read Log DMA Ext	47h	DMA
Read Multiple Ext	29h	PIO data-in
Read Native Max Address Ext	27h	Non-data
Read Verify Sector(s) Ext	42h	Non-data
Set Max Address Ext	37h	Non-data
Write DMA Ext	35h	DMA
Write DMA FUA Ext	3Dh	DMA
Write Multiple Ext	39h	PIO data-out
Write Multiple FUA Ext	CEh	PIO data-out
Write Sector(s) Ext	34h	PIO data-out

Native Command Queuing (NCQ)

Command	Code	Protocol
Read FPDMA Queued	60h	DMA Queued
Write FPDMA Queued	61h	DMA Queued

Trusted

Command	Code	Protocol
Trusted Send	5Eh	PIO data-out
Trusted Send DMA	5Fh	DMA
Trusted Receive	5Ch	PIO data-in
Trusted Receive DMA	5Dh	DMA
Trusted (Non-Data)	5Bh	Non-data
Trusted Send	5Eh	PIO data-out

Data Set Management and Seek

Command	Code	Protocol
Data Set Management	06h	DMA
Seek	70h	Non-data

Identify Device (ECh) Data

The Identify Device (ECh) command enables the host to receive parameter information from the controller. This command has the same protocol as the Read Sector(s) command. The parameter words in the buffer have the arrangement and meanings defined in the following table.

Word	F/V/X	Value	Description
0	F	0440h	General Configuration
1	X	3FFFh	Default Number of Cylinders
2	V	C837h	Reserved
3	X	0010h	Default Number of Heads
4	X	0000h	Obsolete
5	X	0000h	Obsolete
6	X	003Fh	Default Number of Sectors per Track
7-8	V	0000h	Reserved
9	X	0000h	Obsolete
10-19	F	XXXXh	Serial Number in ASCII (Right justified)
20	X	0000h	Obsolete
21	X	4000h	Obsolete
22	X	0004h	Obsolete
23-26	F	XXXXh	Firmware Revision in ASCII; Big Endian Byte Order in Word
27-46	F	XXXXh	Model Number in ASCII (Left justified); Big Endian Byte Order in Word
47	F	0000h	Maximum Number of Sectors on Read/Write Multiple Command
48	F	4000h	Trusted computing feature set options
49	F	2F00h	Capabilities
50	F	4000h	Capabilities
51	X	0000h	Obsolete
52	X	0000h	Obsolete
53	F	0007h	Words 88 and 70 :64 valid
54	X	3FFFh	Obsolete
55	X	0010h	Obsolete
56	X	003Fh	Obsolete
57	X	FC10h	Obsolete
58	X	00FBh	Obsolete
59	V	0101h	Multiple Sector Setting

Word	F/V/X	Value	Description
60-61	F	XXXXh	Total number of user addressable logic sectors
62	X	0000h	Obsolete
63	F	0007h	Multiple DMA transfer
64	F	0003h	Advanced PIO transfer mode supported
65	F	0078h	Minimum Multiword DMA Transfer Cycle Time per Word
66	F	0078h	Recommended Multiword DMA Transfer Cycle Time
67	F	0078h	Minimum PIO Transfer Cycle Time without Flow Control
68	F	0078h	Minimum PIO Transfer Cycle Time with IORDY Flow Control
69	F	4100h	Additional Features
70-74	F	0000h	Reserved
75	F	001Fh	Queue Depth
76	F	C50Eh	Serial ATA Capabilities <ul style="list-style-type: none"> • Supports Serial ATA Gen3 • Supports Serial ATA Gen2 • Supports Serial ATA Gen1 • Supports receipt of Host Initiated Power Management requests • Supports Native Command Queuing
77	F	0006h	Serial ATA Additional Capability; DevSleep_to_ReducedPwrState
78	F	0044h	Serial ATA Features Supported <ul style="list-style-type: none"> • Supports Software Settings Preservation • Supports Initiating Power Management
79	V	0040h	Serial ATA features enabled
80	F	07F0h	Major Version Number (ACS-3)
81	F	0028h	Minor Version Number
82	F	446Bh	Command Sets Supported 0
83	F	7401h	Command Sets Supported 1
84	F	4161h	Command Sets Supported 2
85	V	4029h	Command Set/Feature Enabled 0
86	V	B401h	Command Set/Feature Enabled 1
87	V	4161h	Command Set/Feature Enabled 2
88	V	207Fh	Ultra DMA Mode Supported and Selected
89	F	8001h	Time required for a Normal Erase Mode Security Erase Unit Command
90	F	800Ah	Time required for an Enhanced Erase Mode Security Erase Unit Command
91	V	00FEh	Current Advanced Power Management Value
92	V	0000h	Master Password revision code
93-99	V	0000h	Reserved
100-103	V	XXXXh	Maximum User LBA for 48-bit Address Feature Set
104-105	V	0000h	Reserved
106	F	4000h	Sector size
107-127	V	0000h	Reserved
128	V	0021h	Security Status
129-159	X	XXXXh	Virtium Specific
160	X	0000h	Power Requirement Description
161-167	X	0000h	Reserved
168	F	0003h	Reserved
169	X	0001h	Data Set Management supported
170-205	F	0000h	Reserved
206	F	0038h	SCT Command Transport
207-208	F	0000h	Reserved
209	X	4000h	Reserved
210-216	X	0000h	Reserved

Word	F/V/X	Value	Description
217	X	0001h	Non-rotating Media (SSD)
218-221	X	0000h	Reserved
222	X	103Fh	Transport Major Revision (SATA Revision 3.1)
223-233	X	0000h	Reserved
234	X	0001h	Minimum number of 512 byte units per segmented download
235	X	0100h	Maximum number of 512 byte units per segmented download
236-254	X	0000h	Reserved
255	X	XXXXh	Integrity Word - Checksum

Notes:

1. F = content (byte) is fixed and does not change.
2. V = content (byte) is variable and may change depending on the state of the device or the commands executed by the device.
3. X = content (byte) is specific to manufacturer and may be fixed or variable.

6. SMART Attributes

Introduction

Self-Monitoring, Analysis, and Reporting Technology (SMART) is a system that monitors the device condition according to indicators reported by the device itself. This system is designed to anticipate and predict any failures that might occur, thereby allowing the user to prevent data loss or corruption.

This section is for informational purposes only and about the SMART commands and attributes implemented by Virtium LLC., including the data structures returned by those commands.

Note: Please refer to ACS-3 Specification for information on how to invoke the SMART command.

SMART Subcommands

The following table defines the SMART command set that is supported by the SSDs.

Value	Command
D0h	SMART Read Data
D1h	SMART Read Attribute Threshold
D2h	SMART Enable/Disable Auto-save
D3h	SMART Save Attribute Values
D4h	SMART Execute Off-Line immediate
D5h	SMART Read Log
D6h	SMART Write Log
D8h	SMART Enable Operations
D9h	SMART Disable Operations
DAh	SMART Return Status

SMART Attribute Definitions

The following table defines the SMART data attributes that are currently supported. These SMART attributes are located at Offset 2 of the SMART Data Structure.

ID (Hex)	ID (Decimal)	Description	Type
01	1	Raw Read Error Rate: Rate of CRC errors occurred over the total number of LBA read. Legacy attribute from HDDs. Kept in SMART for host compatibility issues.	Reset at power on
05	5	Reallocated Sector Count: Count of sectors moved to the spare area.	
09	9	Power-On Time Count: Cumulative number of power-on hours while drive is in active mode over the life of the device.	Life Cumulative
0C	12	Drive Power Cycle Count: Cumulative count of power cycle event (on/off) over the life of the device. This attribute includes both proper power down and unsafe power down	Life Cumulative
A0	160	Uncorrectable Sector Count Read/Write: Total Count of uncorrectable errors when device performing reading/writing operation	Reset at power on
A1	161	Total number of overall valid spare block	
A3	163	Number of Initial Invalid Block: Total number of bad blocks found during the card initialization	
A4	164	Total Erase Count: Total number of erase operations those have been performed	Life Cumulative
A5	165	Maximum Erase Count: The maximum number of erase operations on any active block	Life Cumulative
A6	166	Minimum Erase Count: The minimum number of erase operations on any active block	Life Cumulative
A7	167	Average Erase Count: Total number of erase operations over the total available blocks	Life Cumulative
A8	168	NAND Endurance: Max erase count of the NAND	
B1	177	Total wear level count: Total number of wear leveling events	Life Cumulative
B5	181	Total Program Fail: Total number of failed program requests (failed writes)	Life Cumulative
B6	182	Total Erase Fail: Total number of failed erase requests	Life Cumulative
BB	187	Uncorrectable Error Count: The count of errors that could not be recovered using hardware ECC	Life Cumulative
C0	192	Unsafe Power Off: Count of Unsafe power off. Power off without STANDBY-IMMEDIATE command being the last command	Life cumulative
C2	194	SSD Temperature: Indicates the current internal temperature of the SSD controller (in degrees centigrade).	
C3	195	Hardware ECC Recovered: Count of correctable ECC	Life cumulative
C4	196	Reallocation Event Count: Count of Sector remap operations. Number of all (successful and failed) remap operations	Life Cumulative
C6	198	Off-Line Uncorrectable Sector Count: Count of uncorrectable errors when reading/writing	
C7	199	UltraDMA CRC Error Count: Total CRC error count of the SATA interface	Life Cumulative
E8	232	Available Reserved Space: Reports the reserved space of the SSD as a percentage (100% to 0%). When this number reaches zero, the SSD will go into read-only mode	Life cumulative
F1	241	Total LBAs Written: Total LBAs written (each write unit = 32MB)	Life cumulative
F2	242	Total LBAs Read: Total LBAs read (each read unit = 32MB)	Life cumulative
F8	248	Remaining Life Left: Reports remaining life of the SSD as a percentage (100% to 0%). When this number reaches zero, the	Life cumulative

ID (Hex)	ID (Decimal)	Description	Type
		SSD will not go into read-only mode and will continue to operate as normal. The percentage is based on the number of factors and accounts for the number of program/erases cycles the device's NAND flash can endure. This provides guidance on the anticipated lifespan for the device and allows for proactive transfer of data before eventual device failure.	
F9	249	Remaining Spare Block: Reports remaining spare blocks as a percentage (100% to 0%). When this number reaches zero, the SSD will go into read-only mode.	Life Cumulative
FA	250	Total written to NAND (SLC): Total Written to NAND SLC region (each write unit = 32MB)	Life Cumulative
FB	251	Total written to NAND (TLC): Total Written to NAND TLC region (each write unit = 32MB)	Life Cumulative

7. Industry Standards

Reference Title	Date / Revision	Location
ATA/ATAPI-8	September 2008	http://www.t13.org
ACS-3 - ATA/ATAPI Command Set-3	October 2013	http://www.t13.org
SATA 3.1	July 2011	http://www.sata-io.org
JEDEC	JESD22-B110B.01	Mechanical Shock – Device and Subassembly, Revision of JESD22-B110B, June 2019, http://www.jedec.org
JEDEC	JESD22-B103B.01	Vibration, Variable Frequency, Minor revision to JESD22-B103-B, September 2016, http://www.jedec.org
JEDEC	JESD218A	Solid-State Drive (SSD) Requirements and Endurance Test Method, February 2011, http://www.jedec.org
JEDEC	JESD219	Solid-State Drive (SSD) Endurance Workloads, September 2010, http://www.jedec.org

8. Certifications and Compliance

Compliance / Certification	Description
CE and FCC Compliant	Class: FCC Part 15 Subpart B Class B:2011 Declaration of Conformity registration No. STE120607699
RoHS Compliant	Restriction of Hazardous Substance Directive
UL Certified	Underwriters Laboratories, Inc. 94V-0
WEEE Certified	Waste, Electrical and Electronic Equipment Directive
ISO-9001 AS9001 Rev. C Certificate	Quality Management
ISO-14001 Certificate	Environmental Management

9. Contact Information

Corporate Headquarters and Manufacturing Location:
30052 Tomas, Rancho Santa Margarita, CA 92688 USA

Main Website: www.virtium.com
Contacts / Sales: <http://www.virtium.com/contacts-sales/>
Toll Free: (888) VIRTUUM / (888) 847.8486
Telephone: 1+ (949) 888.2444
Fax: +1 (949) 888.2445
Customer Support custserv@virtium.com

10. Revision History

Date	Revision	Page(s)	Description
12/04/2020	0.90	All	Preliminary



Virtium manufactures storage and memory and solutions for the world's foremost industrial embedded OEMs. For over two decades, we have designed, manufactured and supported our products in the USA – fortified by a network of global locations. Our world-class technology and unsurpassed support provide a superior customer experience that continuously results in better industrial embedded products for an increasingly interconnected world.

© Copyright 2020. All rights reserved. Virtium®, StorFly®, TuffDrive®, vtView®, vtGuard® are registered trademarks and StorKit™, vtSecure™ and vtTools™ are trademarks of Virtium LLC. All other non-Virtium product names are trademarks of their respective companies.