



StorFly® M.2 Type 2280 Solid-State Drive

PCIe Gen3 x4 / NVMe 1.3 - Series 6, 3D TLC

VSFAN8CI1920G-V11-H

Datasheet - Rev. 1.0



1. Description

Virtium's StorFly® M.2 NVMe PCIe solid-state drive (SSD) technology is designed for the unique storage demands and workload requirements of a broad range of industrial embedded systems, including networking, industrial automation, medical systems, transportation, point-of-sale terminals, and data recorders. StorFly CE class solid-state drives are mainstream productivity solutions designed to provide the ideal balance of power, performance, endurance, reliability, long ordering life, and cost all in a rugged industrial design suitable for environmental extremes.

Features

Capacity

- 1920 GB

3D TLC NAND

Sequential Performance

- 128kB Sequential Read: 3,200 MB/s
- 128kB Sequential Write: 2,500 MB/s

Random Performance

- 4kB IOPS Read: up to 300,000
- 4kB IOPS Write: up to 300,000

Power: 3.3V±5%

- 128kB Sequential Read: 5.45 W
- 128kB Sequential Write: 6.05 W
- 4kB Random Read: 3.77 W
- 4kB Random Write: 4.12 W
- Idle: 0.73 W

Temperature Ranges

- Industrial: -40°C to 85°C
- Non-Operating: -40°C to 85°C

Reliability

- Advanced LDPC ECC
- MTBF: >2M hours

Endurance

- JESD219A: 1,454 TBW
- Sequential: 6,128 TBW

vtGuard® Power Fail Protection

- Integrated power fail protection
- Preserves static data in the event of power failure
- Cache/buffer contents restored at power-on

SMART Attribute Reporting

- Monitors device health
- Anticipates and predicts failures

Mechanical Dimensions

- M.2 Type 2280-D2-M Form Factor
- Length x Width x Height mm (inches) with heat spreader
80.00 (3.14) x 22.00 (0.866) x 4.60 (0.181)

Compliance

- PCIe Specification, Revision 3.1a
- NVMe Specification, Revision 1.3
- FCC, CE, UL, RoHS, WEEE

Environmental (Non-operating)

- Humidity (non-condensing): 5% to 95%
- Shock: 1500G, half-sine wave, 0.5ms duration
- Vibration: 20G, 20 Hz to 2000 Hz

Data Security

- Integrated AES-256 encryption (data-at-rest)
- Crypto Erase
- TCG/ Opal 2.0-compliant SED⁽¹⁾

StorKit™ Software - visit virtium.com to learn more.

- vtView®, vtSecure™, vtTools™

Note: (1) Available in parts with -T part number extension



Electrostatic Discharge (ESD) can damage this device. When handling the device, always wear a grounded wrist strap and use a static dissipative surface.



Any damage to the unit that occurs after its removal from the shipping package and ESD protective bag is the responsibility of the user.

Part Numbering System

V SF AN8 C I 1920G - V11 - H

Where:	
V	= Virtium
SF	= StorFly
AN8	= Form Factor / Interface: AN8 = M.2 Type 2280-D2-M, NVMe / PCIe 3.1 High Performance Gen3 x4 NVMe 1.3 DRAM SSD controller
C	= Product Class: C = CE
I	= Operating Temperature: I = Industrial (-40°C to 85°C)
1920G	= 1920GB (1GB = 1,000,000,000 bytes)
V11	= Virtium Proprietary
H	= With Heat spreader

2. Specifications

Interface

Interface	PCI Express Base Specification Rev 3.1a (PCIe)
Command	NVM Express Revision 1.3

Capacity

Unformatted Capacity (GB) ⁽¹⁾	User-Addressable LBA ⁽²⁾	User-Addressable Capacity Bytes
1920	3,750,748,848	1,920,383,410,176
(1) 1GB = 1,000,000,000 bytes. LBA: Logical Block Address; Logical Block Size = 512 Bytes/1 Sector.		
(2) LBA: Logical Block Address; Logical Block Size = 512 Bytes/1 Sector.		

Performance

Capacity GB	Performance Throughput ⁽¹⁾ 128kB File, Queue Depth (QD) = 64		IOPS ⁽¹⁾ 4kB File, Queue Depth (QD) = 64	
	Sequential Read MB/s	Sequential Write MB/s	100% Random Read	100% Random Write
1920	3,200	2,500	300,000	300,000
(1) Performance is based on fresh out-of-box condition formatted with NTFS filesystem and running CrystalDiskMark 7.0.0 with file size 1024MB. Actual results may vary depending on file system, workload, and SSD condition.				

Power Consumption - 3.3V Supply

Sequential Read ⁽¹⁾ 128kB, QD = 32	Sequential Write ⁽¹⁾ 128kB, QD = 32	Random Read ⁽¹⁾ 4kB, QD = 32	Random Write ⁽¹⁾ 4kB, QD = 32	Idle
5.45 W	6.05 W	3.77 W	4.12 W	0.73 W
(1) Power consumption tests were done using Oakgate test system at 25°C				

Temperature and Humidity

Part Number	Operating Temperature	Non-Operating ⁽¹⁾ Temperature	Humidity (Non-Condensing)
VSFAN8CI1920G-V11-H	-40°C to 85°C	-40°C to 85°C	5% to 95%
(1) Maximum non-operating temperature assumes data is stored on the SSD. Temperatures above 85°C are beyond NAND specification for data retention. Please see <i>Temperature Considerations for Industrial Embedded SSDs</i> whitepaper under the industrial SSD section of Virtium website (Virtium.com)			

Shock and Vibration

Reliability	Test Conditions	Reference Standards
Shock	1500G, half-sine wave, 0.5ms duration	JESD22-B110B.01
Vibration	20G, 20 Hz to 2000 Hz	JESD22-B103B.01

3. Reliability

Endurance

Capacity (GB)	JESD218A ⁽¹⁾ & JESD219 Enterprise Workloads		100% Sequential Workloads	
	Total Bytes Written TBW (TB)	Drive Writes per day (3 years)	Total Bytes Written TBW (TB)	Drive Writes per day (3 years)
1920	1,454	0.69	6,128	2.91
(1) JESD218A assumes an active temperature at 55°C and a retention temperature at 40°C				

Mean Time Between Failures (MTBF)

The SSD achieves a MTBF of greater than 2,000,000 hours predicted and is derived from the component reliability data using Telcordia SR-332 methods at 40°C and tested under standard environmental operating conditions.

vtGuard® Power-Fail Protection

vtGuard® is an integrated power failure protection technology that will preserve data on the SSD if a sudden power failure should occur. It will also transfer the write cache (metadata, mapping tables) contents to the non-volatile flash and restore the contents upon power restoration. This data will be preserved regardless of the duration of the power failure event. This technology also ensures that the SSD will be recoverable after sudden power failure events although a rebuild of the mapping tables may delay readiness of the SSD on the ensuing power cycle on larger capacities.

4. Physical Specifications

Pin Layout / Assignments

Pin	Signal	Description	Pin	Signal	Description
1	CONFIG_3	Ground	2	3.3V	3.3V Source
3	GND	Ground	4	3.3V	3.3V Source
5	PETn3	PCIe Lane 3 Tx-	6	N/C	No Connect
7	PETp3	PCIe Lane 3 Tx+	8	N/C	No Connect
9	GND	Ground	10	LED1#	Device Active Signal#
11	PERn3	PCIe Lane 3 Rx-	12	3.3V	3.3V Source
13	PERp3	PCIe Lane 3 Rx+	14	3.3V	3.3V Source
15	GND	Ground	16	3.3V	3.3V Source
17	PETn2	PCIe Lane 2 Tx-	16	3.3V	3.3V Source
19	PETp2	PCIe Lane 2 Tx+	20	N/C	No Connect
21	CONFIG_0	Ground	22	N/C	No Connect
23	PERn2	PCIe Lane 2 Rx-	24	N/C	No Connect
25	PERp2	PCIe Lane 2 Rx+	26	N/C	No Connect
27	GND	Ground	28	N/C	No Connect
29	PETn1	PCIe Lane 1 Tx-	30	N/C	No Connect
31	PETp1	PCIe Lane 1 Tx+	32	N/C	No Connect
33	GND	Ground	34	N/C	No Connect
35	PERn1	PCIe Lane 1 Rx-	36	N/C	No Connect
37	PERp1	PCIe Lane 1 Rx+	38	DEVSLP	No Connect
39	GND	Ground	40	N/C	No Connect
41	PETn0	PCIe Lane 0 Tx-	42	N/C	No Connect
43	PETp0	PCIe Lane 0 Tx+	44	N/C	No Connect
45	GND	Ground	46	N/C	No Connect
47	PERn0	PCIe Lane 0 Rx-	48	N/C	No Connect
49	PERp0	PCIe Lane 0 Rx+	50	PERST#	PCIe Reset#
51	GND	Ground	52	CLKREQ#	PCIe Device Clock Request#
53	REFCLKN	PCIe Reference Clock-	54	PEWake#	No Connect
55	REFCLKP	PCIe Reference Clock+	56	N/C	No Connect
57	GND	Ground	58	N/C	No Connect
Key			Key		
67	N/C	No Connect	68	SUSCLK	No Connect
69	CONFIG_1	No Connect	70	3.3V	3.3V Source
71	GND	Ground	72	3.3V	3.3V Source
73	GND	Ground	74	3.3V	3.3V Source
75	CONFIG_2	Ground	-	-	-

Note: Pins 59 - 66 are displaced by the connector key.

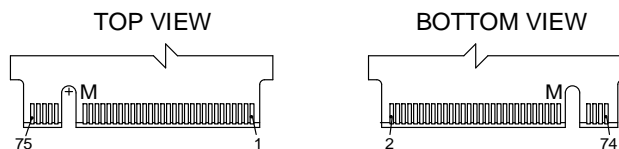

Pin Layout

Mechanical Dimensions

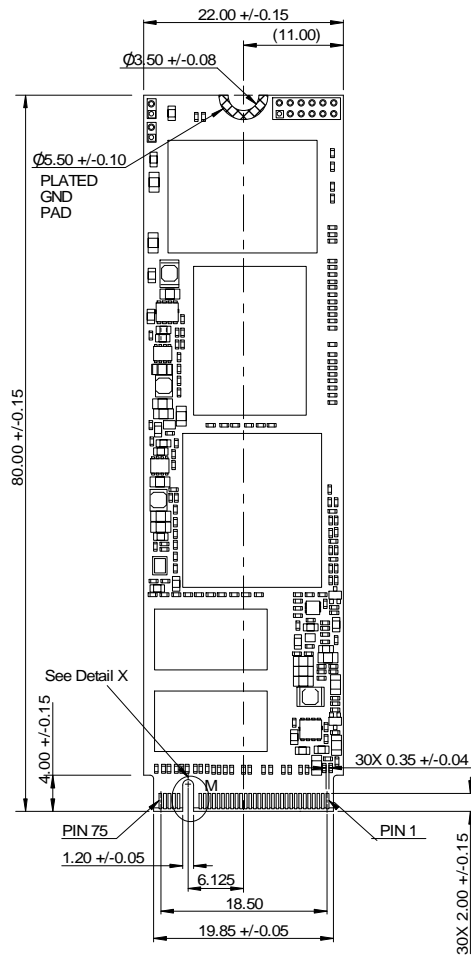

TOP VIEW

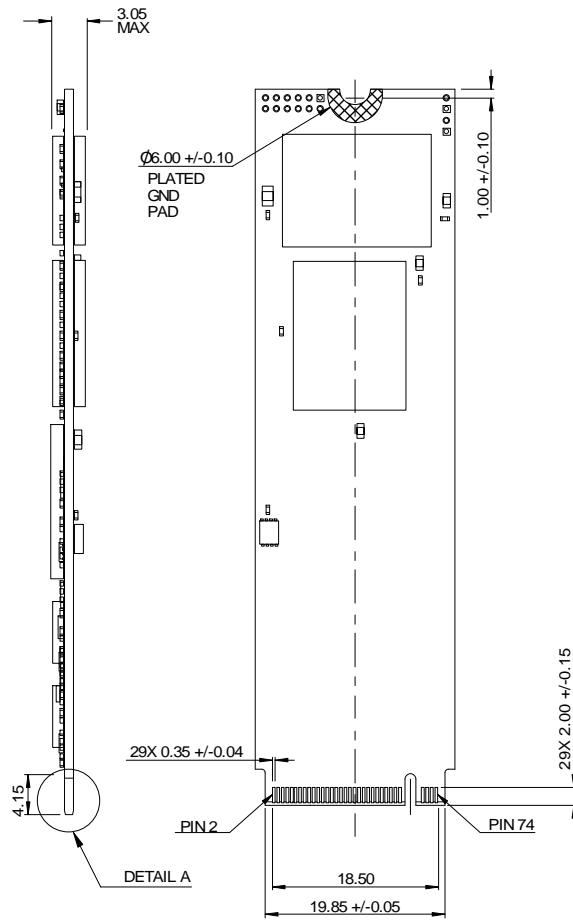

BOTTOM VIEW

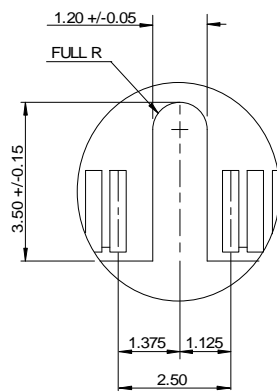

Detail X
Scale 5:1

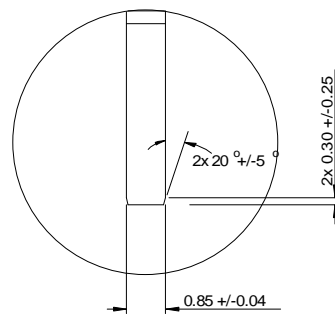

Detail Y
Scale 5:1

Note:

1. All dimensions are in millimeters
2. The dimensional diagram is for reference only

MODULE WITH HEAT SPREADER ON BOTH SIDES

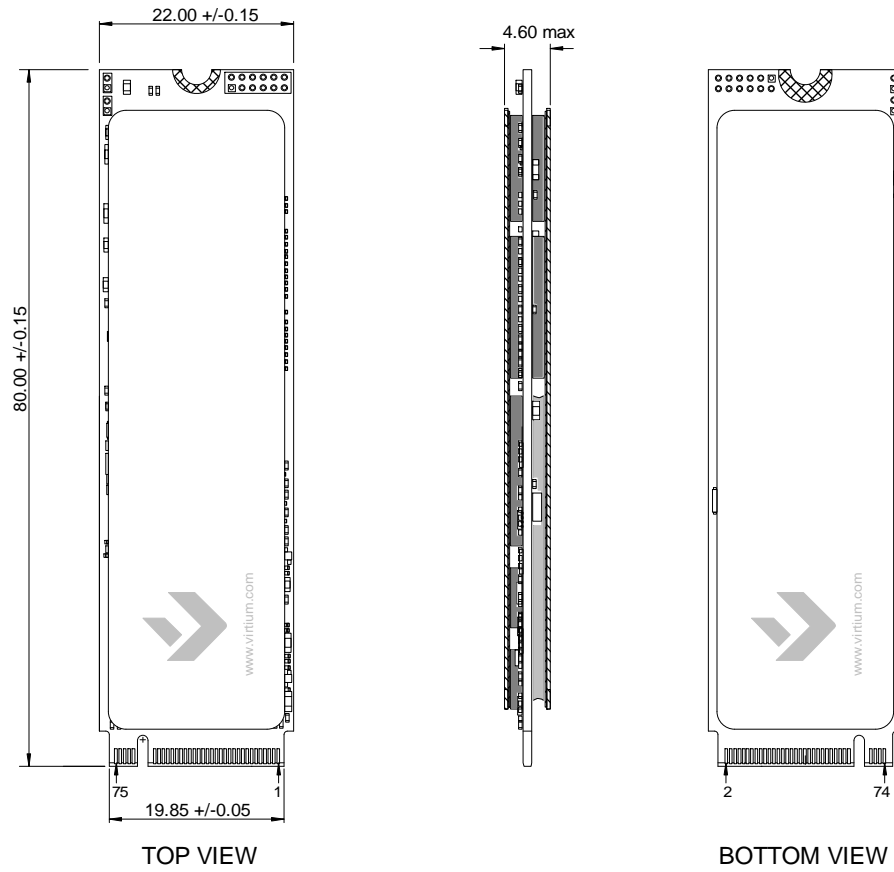

HEAT SPREADER DESIGN

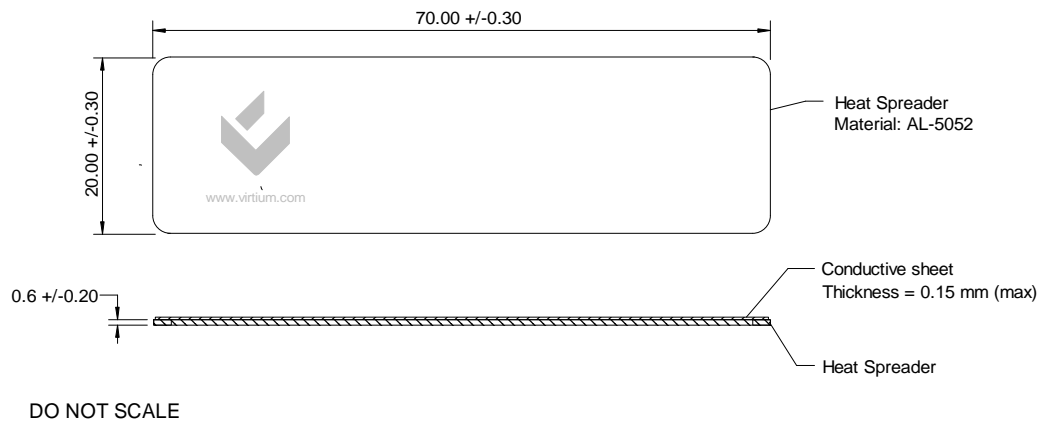

Note:
1. All dimensions are in millimeters

5. NVMe Command Set Specifications

Introduction

NVM Express, or NVMe, is a register level interface that is intended to simplify the configuration of NVMe devices. The standard is comprised of various terms that are important to know when implementing NVMe devices.

Note: This section is intended for informational purposes and presents an overview of the NVMe command set specification. The user should consult the cited NVMe Specification, Revision 1.3 for details.

Admin Command Set

Opcode (Hex)	Command	Opcode (07)	Opcode (06:02)	Opcode (01:00)	Namespace Identifier Used
		Generic Command	Function	Data Transfer	
00h	Delete I/O Submission Queue	0b	000 00b	00b	No
01h	Create I/O Submission Queue	0b	000 00b	01b	No
02h	Get Log Page	0b	000 00b	10b	Yes
04h	Delete I/O Completion Queue	0b	000 01b	00b	No
05h	Create I/O Completion Queue	0b	000 01b	01b	No
06h	Identify	0b	000 01b	10b	Yes
08h	Abort	0b	000 10b	00b	No
09h	Set Features	0b	000 10b	01b	Yes
0Ah	Get Features	0b	000 10b	10b	Yes
10h	Firmware Activate	0b	001 00b	00b	No
11h	Firmware Image Download	0b	001 00b	01b	No
80h	Format NVM	1b	000 00b	00b	Yes
0Ch	Asynchronous Event Request	0b	000 11b	00b	No

NVMe I/O Command Set

Opcode (Hex)	Command	Opcode (06:02) Function	Opcode (01:00) Data Transfer
00h	Flush	000 00b	00b
01h	Write	000 00b	01b
02h	Read	000 00b	10b
04h	Write Uncorrectable	000 01b	00b
05h	Compare	000 01b	01b
08h	Write Zeros	000 10b	00b
09h	Dataset Management	000 10b	01b

NVMe Log Pages

The following table lists the mandatory log pages that are supported by the M.2 NVMe PCIe SSD. These log pages are defined in the NVMe 1.3 Specification. See *the NVMe 1.3 Specification, Section 5.15*.

Command	Protocol
00h	Reserved
01h	Error Information
02h	SMART / Health Information
03h	Firmware Slot Information
04h	Changed Namespace List
05h	Commands Supported and Effects
06h	Device Self-test
07h	Telemetry Host-Initiated
08h	Telemetry Controller-Initiated
09h – 6Fh	Reserved
70h	Discovery (refer to the NVMe over Fabrics specification)
71h-7Fh	Reserved for NVMe over Fabrics
80h-BFh	I/O Command Set Specific
C0h-FFh	Vendor specific

SMART / Health Log Information

Bytes	Description														
0	<p>Critical Warning: This field indicates critical warnings for the state of the controller. Each bit corresponds to a critical warning type; multiple bits may be set. If a bit is cleared to '0', then that critical warning does not apply. Critical warnings may result in an asynchronous event notification to the host. Bits in this field represent the current associated state and are not persistent.</p> <table border="1"> <thead> <tr> <th>Bit</th> <th>Definition</th> </tr> </thead> <tbody> <tr> <td>0</td> <td>If set to '1', then the available spare space has fallen below the threshold.</td> </tr> <tr> <td>1</td> <td>If set to '1', then a temperature is above an over temperature threshold or below an under temperature threshold (refer to section 5.21.1.4).</td> </tr> <tr> <td>2</td> <td>If set to '1', then the NVM subsystem reliability has been degraded due to significant media related errors or any internal error that degrades NVM subsystem reliability.</td> </tr> <tr> <td>3</td> <td>If set to '1', then the media has been placed in read only mode.</td> </tr> <tr> <td>4</td> <td>If set to '1', then the volatile memory backup device has failed. This field is only valid if the controller has a volatile memory backup solution.</td> </tr> <tr> <td>7:5</td> <td>Reserved</td> </tr> </tbody> </table>	Bit	Definition	0	If set to '1', then the available spare space has fallen below the threshold.	1	If set to '1', then a temperature is above an over temperature threshold or below an under temperature threshold (refer to section 5.21.1.4).	2	If set to '1', then the NVM subsystem reliability has been degraded due to significant media related errors or any internal error that degrades NVM subsystem reliability.	3	If set to '1', then the media has been placed in read only mode.	4	If set to '1', then the volatile memory backup device has failed. This field is only valid if the controller has a volatile memory backup solution.	7:5	Reserved
Bit	Definition														
0	If set to '1', then the available spare space has fallen below the threshold.														
1	If set to '1', then a temperature is above an over temperature threshold or below an under temperature threshold (refer to section 5.21.1.4).														
2	If set to '1', then the NVM subsystem reliability has been degraded due to significant media related errors or any internal error that degrades NVM subsystem reliability.														
3	If set to '1', then the media has been placed in read only mode.														
4	If set to '1', then the volatile memory backup device has failed. This field is only valid if the controller has a volatile memory backup solution.														
7:5	Reserved														
2:1	Composite Temperature: Contains a value corresponding to a temperature in degrees Kelvin that represents the current composite temperature of the controller and namespace(s) associated with that controller. The manner in which this value is computed is implementation specific and may not represent the actual temperature of any physical point in the NVM subsystem.														
3	Available Spare: Contains a normalized percentage (0 to 100%) of the remaining spare capacity available.														
4	Available Spare Threshold: When the Available Spare falls below the threshold indicated in this field, an asynchronous event completion may occur. The value is indicated as a normalized percentage (0 to 100%).														
5	Percentage Used: The percentage of NVM subsystem life used based on the actual usage and the prediction of NVM life. A value of 100 indicates that the estimated endurance of the NVM in the NVM subsystem has been consumed, but may not indicate an NVM subsystem failure. The value is allowed to exceed 100. Percentages greater than 254 shall be represented as 255. This value shall be updated once per power-on hour (when the controller is not in a sleep state).														
31:6	Reserved														
47:32	Data Units Read: Contains the number of 512 byte data units the host has read from the controller; this value does not include metadata. This value is reported in thousands (i.e., a value of 1 corresponds to 1000 units of 512 bytes read) and is rounded up. When the LBA size is a value other than 512 bytes, the controller shall convert the amount of data read to 512 byte units.														

Bytes	Description
63:48	Data Units Written: Contains the number of 512 byte data units the host has written to the controller; this value does not include metadata. This value is reported in thousands (i.e., a value of 1 corresponds to 1000 units of 512 bytes written) and is rounded up. When the LBA size is a value other than 512 bytes, the controller shall convert the amount of data written to 512 byte units.
79:64	Host Read Commands: Contains the number of read commands completed by the controller.
95:80	Host Write Commands: Contains the number of write commands completed by the controller.
111:96	Controller Busy Time: Contains the amount of time the controller is busy with I/O commands. The controller is busy when there is a command outstanding to an I/O Queue (specifically, a command was issued via an I/O Submission Queue Tail doorbell write and the corresponding completion queue entry has not been posted yet to the associated I/O Completion Queue). This value is reported in minutes.
127:112	Power Cycles: Contains the number of power cycles.
143:128	Power On Hours: Contains the number of power-on hours. This may not include time that the controller was powered and in a non-operational power state.
159:144	Unsafe Shutdowns: Contains the number of unsafe shutdowns. This count is incremented when a shutdown notification (CC.SHN) is not received prior to loss of power.
175:160	Media and Data Integrity Errors: Contains the number of occurrences where the controller detected an unrecovered data integrity error. Errors such as uncorrectable ECC, CRC checksum failure, or LBA tag mismatch are included in this field.
191:176	Number of Error Information Log Entries: Contains the number of Error Information log entries over the life of the controller.

6. Industry Standards

Reference Title	Date / Revision	Location
NVMe	NVMe 1.3	NVM Express Working Group. NVM Express (NVMe) Specification, Revision 1.3, May 1, 2017. http://www.nvmexpress.org .
PCI-SIG	Revision 3.1a	PCI Express Base Specification, Revision 3.1a, December 7, 2015. https://pcisig.com/
PCI-SIG	Revision 1.1	PCI Express M.2 Specification, Revision 1.1, December 15, 2016. https://pcisig.com/
JEDEC	JESD22-B110B.01	Mechanical Shock – Device and Subassembly, Revision of JESD22-B110B, June 2019, http://www.jedec.org
JEDEC	JESD22-B103B.01	Vibration, Variable Frequency, Minor revision to JESD22-B103-B, September 2016, http://www.jedec.org
JEDEC	JESD218A	Solid-State Drive (SSD) Requirements and Endurance Test Method, February 2011, http://www.jedec.org
JEDEC	JESD219	Solid-State Drive (SSD) Endurance Workloads, September 2010, http://www.jedec.org

7. Certifications and Compliance

Compliance / Certification	Description
CE and FCC Compliant	Class: FCC Part 15 Subpart B Class B:2011 Declaration of Conformity registration No. STE120607699
RoHS Compliant	Restriction of Hazardous Substance Directive
UL Certified	Underwriters Laboratories, Inc. 94V-0
WEEE Certified	Waste, Electrical and Electronic Equipment Directive
ISO-9001 AS9001 Rev. C Certificate	Quality Management
ISO-14001 Certificate	Environmental Management

8. Contact Information

Corporate Headquarters and Manufacturing Location:

30052 Tomas, Rancho Santa Margarita, CA 92688 USA

Main Website:	www.virtium.com
Contacts / Sales:	http://www.virtium.com/contacts-sales/
Toll Free:	(888) VIRTUUM / (888) 847.8486
Telephone:	1+ (949) 888.2444
Fax:	+1 (949) 888.2445
Customer Support	custserv@virtium.com

9. Revision History

Date	Revision	Page(s)	Description
01/25/2021	1.0	All	Initial release



Virtium manufactures storage and memory and solutions for the world's foremost industrial embedded OEMs. For over two decades, we have designed, manufactured and supported our products in the USA – fortified by a network of global locations. Our world-class technology and unsurpassed support provide a superior customer experience that continuously results in better industrial embedded products for an increasingly interconnected world.

© Copyright 2020. All rights reserved. Virtium®, StorFly®, TuffDrive®, vtView®, vtGuard® are registered trademarks and StorKit™, vtSecure™ and vtTools™ are trademarks of Virtium LLC. All other non-Virtium product names are trademarks of their respective companies.